



LBX INC65

High Precision Constant Temperature Incubator

Please read the User Manual carefully before use, and follow all operating and safety instructions!



user manual

english

User Manual



LBX INC65

High Precision Constant Temperature Incubator

Preface

Users should read this Manual carefully, follow the instructions and procedures, and beware of all the cautions when using this instrument.

Service

If help is needed, you can always contact your dealer or Labbox via www.labbox.com (declare an incidence)

Please, provide the customer service representative with the following information:







- Serial number
- Description of the problem
- Your contact information

Warranty

This instrument is guaranteed to be free from defects in materials and workmanship under normal use and service, for a period of 24 months from the date of invoice. The warranty is extended only to the original purchaser. It shall not apply to any product or parts which have been damaged on account of improper installation, improper connections, misuse, accident or abnormal conditions of operation.

For claim under the warranty, please contact your supplier.

1. Safety Instructions

	Connect the device to an earthed power supply to ensure the safety of the machine and the experiment; connect the power as the machine requires it. The voltage must correspond to the main power supply.
	The use of this instrument in inflammable, explosive, poisonous, or highly corrosive experiments is forbidden.
	Place the incubator on a horizontal, flat, stable table leaving 20 free cm on each side.
	This item must only be used by previously qualified staff that has read the instructions manual and knows how to operate it.
	Do not place the device near any heat source. Keep away from high magnetic fields. Do not put volatile, flammable and explosive materials in the machine, otherwise it could cause an explosion or a fire.
	Non-professionals are not allowed to disassemble and repair this machine.
	Read the instructions manual before using this device.

- When working, wear the necessary personal protective equipment to avoid the risk of:
 - Burns caused by contact with hot surfaces or materials
 - Burns caused by splashing and evaporation of liquids
 - Intoxication caused by release of toxic or flammable gases
- Set up the instrument on a spacious, stable, clean, non-slippery, dry, and fireproof surface that can support the equipment's weight. Do not operate the instrument in explosive atmospheres or with hazardous substances.
- Beware of hazards due to:
 - Flammable materials or media with a low boiling temperature.
- The device and accessories shall be checked before handling prior to each use. Do not use damaged components.
- Pay attention to the setting temperature when dealing with inflammable matters.
- The instrument can only be disconnected from the main power supply by pulling the plug, not the wire.

- Ensure that the main wire does not contact the surface. Do not cover the device.
- Do not place the device in a place exposed to rain, moisture or splashing as this might result in electrical leakage, short circuit or electric shock.
- Do not damage the power plug or the power cord. If it is damaged, the power cord must be replaced. Do not use a non-specified power cord. Do not unplug the power cord during operation. If the instrument is running abnormally, unplug the power cord immediately.
- Do not touch the power plug with wet hands. Before any repair or maintenance is carried out, the power must be disconnected to prevent electrical shock or injury.
- Please wear gloves when repairing and maintaining the instrument.

Other necessary considerations:

- Use a separate power outlet fitted with a grounding wire. Tight the power plug when in use.
- Put off the power plug, before removing the equipment.
- Carefully touch the inner wall of the door, which may be hot.
- Non-professional technical staff could not disassemble the machine privately, Professional staff should repair and replace parts.
- The internal parameters must be set by the specific management person to prevent the function of the controller program from being disturbed by an unknown setting operation.
- The installation location of the equipment must be longer than 20 cm from the wall and from the object.
- Open or close the door gently. Rudely opening or closing the door can easily cause damage to the equipment.
- The surface of the equipment must not be exposed to volatile chemicals such as gasoline or thinner.
- Keep the inside and outside of the box clean, often cleaning debris and smudges.

2. Instructions for use

The instrument has been designed for heating in schools, laboratories, industries and for research purposes. It is not suitable for domestic use or for use in environments that can be hazardous for either the user or the instrument.

3. Inspection

3.1 Unpacking

Unpack the equipment carefully and check for any damages that may have arisen during transportation. If necessary, contact your supplier for technical support.



Note:

If there is any apparent damage on the equipment, please do not plug it into the power line.

3.2 Items list

The package includes the following pieces:

Content	Quantity
Principal unit	1
Power cable	1
Tray	2
User manual	1

4. Meter operation and display instructions

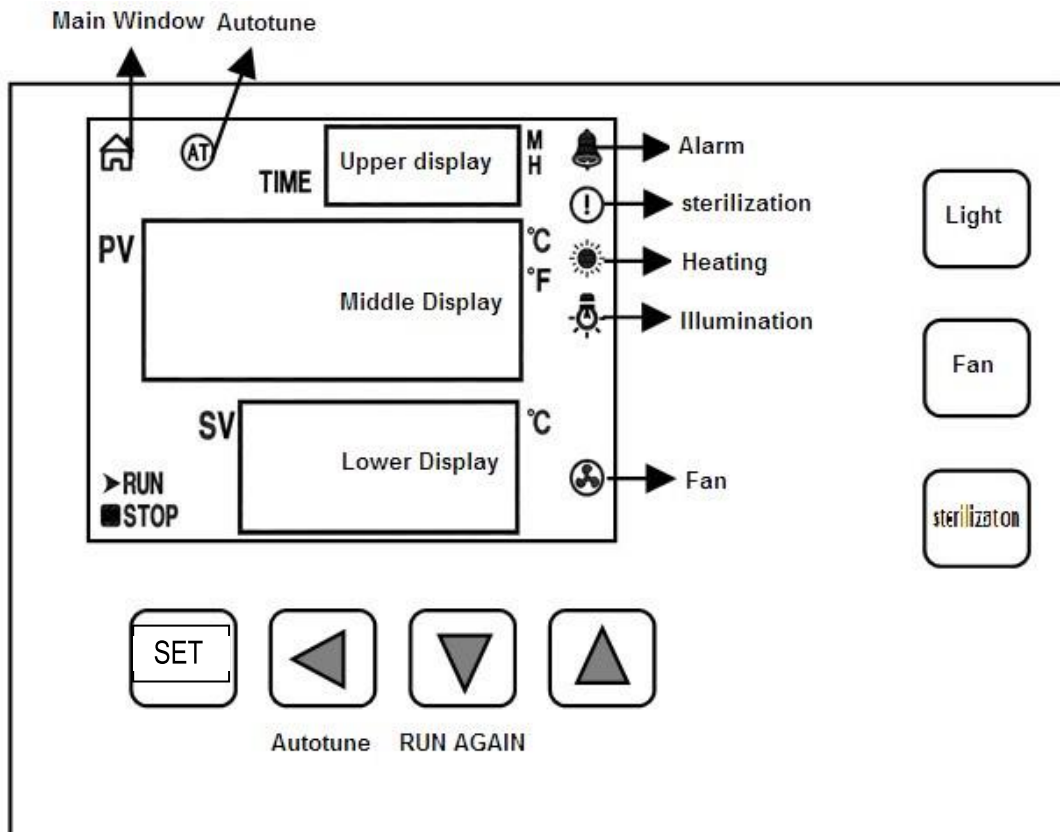

Indicator definition:

1. "Main window" indicator: Light is on in the normal working state (non-set state), otherwise it is off.
2. "Auto-tuning" indicator: This indicator flashes when running the auto-tuning program, otherwise it goes off.
3. "RUN" indicator: This indicator is off when the timer is over, otherwise it stays on.
4. "STOP" indicator: This indicator lights up when the timer expires, otherwise it goes off.
5. "Alarm" indicator: This indicator is on when there is a deviation alarm on temperature or when the temperature measurement is abnormal. When there is a deviation alarm under temperature, this indicator flashes. Under normal operation, this indicator goes off.
6. "Heating" indicator: it lights up when heating there is output, otherwise it lights off.
7. "Light" indicator: it lights up when turned on, otherwise lights are turned off.
8. "Fan" indicator: Fan works when turned on, otherwise it is off.
9. "Sterilization" indicator: Lights up when turned on, otherwise it is off.
10. PV screen: current measurement value
11. SV screen: set parameter value

The **PV screen** will display the real temperature of the working room while the **SV screen** displays the previously set temperature

[Light] key: Click this key to switch the lighting and the corresponding indicator lights up or goes out.

[Fan] key: Click this key to switch the fan and the corresponding indicator lights up or goes out.

[Sterilization] key: Long press this key for 6 seconds to start sterilization, click this key to turn off the sterilization, and the corresponding indicator lights up or goes out.

[Shift] key  : Click this button in the setting state to shift the set value by flickering; in the normal display state, long press this key 6 seconds to enter the temperature auto-tuning selection state.

[Dec] key  : Click this key to decrease the set value in the setting state. Long press this key to decrease the set value continuously. In the normal display state, press this key when the timer runs out. Long press 3 seconds can restart the run.

[Inc] key  : Click this key to increase the set value in the setting state. Long press this key to increase the set value continuously.

Operation and usage

1. The controller is powered on. The middle display area shows [index number and meter type]. The lower display area shows [version number], about 2 seconds into the normal display state.

2. Temperature, time reference and setting

1) If there is no timing function:

Click [Set] button to enter the temperature setting state, the middle display area displays prompt "SP", the lower display area shows the temperature setting value, which can be modified by [Inc], [Decrease] and [Shift] keys go to the desired setting value; then click the [SET] button to exit this setting state and the modified setting value is automatically saved.

2) If there is timing function

Click [Set] button to enter the temperature setting state, the middle display area displays the prompt "SP", the lower display area shows the temperature setting value, the modification method is the same as above; then click the [Set] button, enter the time setting in the status display area. The prompt "ST" is displayed, the upper display area shows the time setting value. Then click the [Set] button to exit the setting status. The modified setting value is automatically saved.

When the time is set to "0", it means there is no timing function and the meter runs continuously. When the set time is not "0", the upper display area shows the running time. When the timer starts, the "time unit" flashes, when the time is up, the operation ends, the upper display area shows "End", and the buzzer intermittently sounds EST Seconds (see the internal parameter table-2) and stop. After the timer runs out, press [Down] for 3 seconds to restart the run.

3. Abnormal temperature measurement alarm

If " --- " is displayed in the middle display area, it means that the temperature sensor is faulty or the temperature exceeds the measurement range or the controller itself is faulty, the controller automatically disconnects the heating output, the buzzer sounds continuously, and the alarm light is on. Check the temperature sensor and wiring carefully.

4. When the upper deviation exceeds the over-temperature alarm, the buzzer sounds, the warning light is on, and the heating output is turned off; when the lower deviation exceeds the over-temperature alarm, the buzzer sounds, and the warning light flashes; if the temperature value is changed due to over-temperature alarm. The alarm light is on, but the buzzer does not sound.

5. When the buzzer sounds, you can press any key to stop.

System self-tuning

In the normal display state, press the [SHIFT] button for 6 seconds to enter the system self-tuning selection state, the middle display area shows the self-tuning prompt "AT", the lower display area shows "0", you can click [Inc] or [Dec] key to select "1" or "0" to display. When "1" is displayed, click [Set] key, the meter enters the system self-tuning state, and the auto-tuning indicator flashes. After the auto-tuning is completed, the indicator Light stops flashing and **the controller will get a better set of PID parameters**. The parameter values are saved automatically. In the process of system self-tuning, press the [Shift] key for 6 seconds to stop the self-tuning process.

If there is an upper deviation over temperature alarm during the system self-tuning, the warning light will not be on and the buzzer will not be called, but the heating alarm relay will be automatically disconnected. The [Set] key is invalid during system auto-tuning.

Reference and setting of temperature internal parameters

In the normal display state, press the [Set] button for 3 seconds, the middle display area displays the password prompt "Lc", the lower display area shows the password value, and is modified by [Inc], [Dec] and [Shift] The required password value. Then click the [Set] button. If the password value is incorrect, the controller automatically returns to the normal display state. If the password value is correct, enter the internal parameter setting state, and then click the [Set] button to modify each parameter in turn. Press and hold the [SET] button for 3 seconds to exit this status. The parameter values are automatically saved. See the tables below for details:

Internal parameter table -1

Parameter indication	Parameter name	Parameter function description	(Range) Default Value
Lc	Password	The parameter value can be viewed and modified when "Lc=3".	0
ALH	Upper deviation Over temperature alarm	When "Temperature measurement > Temperature set value + HAL", there is an upper deviation over temperature alarm.	(0~100.0°C)5.0
ALL	Lower deviation Over temperature alarm	When "Temperature measured value < temperature set value-ALL", there is a lower deviation over temperature alarm. Note: When "ALL=0", the lower deviation alarm is invalid.	(0~100.0°C)0
P	Proportional band	Time proportional effect adjustment.	(0.1~300.0°C) 10.0
I	Integration time	Integral function adjustment.	(1~2000 Second)
d	Differential time	Differential regulation.	(0~1000 Second)
T	Control period	Heating control cycle.	(1~30 Second)5
Pb	Measurement temperature deviation correction	It is commonly used to correct errors that occur during low temperature measurements. $Pb = \text{actual temperature value} - \text{meter measurement}$	(-50.0~50.0°C) 0
PL	Measuring temperature slope correction	It is often used to correct errors that occur during high temperature measurements. $PL = 1000 * (\text{actual temperature value} - \text{meter measurement}) / \text{meter measurement}$	(-999~999) 0
Addr	Communication address	This machine communication address.	(1~32) 1
Loc	Set lock	0: Can modify the temperature or time setting value; 1: It is forbidden to modify the temperature or time setting value.	(0~1) 0

Internal parameter table -2

Parameter indication	Parameter name	Parameter function description	Factory value
Lc	Password	When "Lc=9",the parameter values can be viewed and modified.	0
ndA	Temperature Alarm mode	0: Only temperature deviation overtemperature alarm ; 1: At the same time, there are temperature and lower deviation over temperature alarm.	(0~1) 0
ndc	Temperature control mode	0 : Fuzzy PID control; 1 : Bit control	(0~1) 0
dE1	Bit control Upper deviation	When the "temperature measurement > temperature setting value + dE1", turn offthe heating output.	(0~100.0°C)0
dE2	Bit control Lower deviation	When the "temperature measurement value is less than the temperature setting value DE2", the heating output is turned on. Description: this parameter is effectiveonly when controlling the position.	(0~100.0°C)0
ndT	Timing mode	0 : No timing function ; 1 : Constant temperature timing;2 : Starting up timing ;	(0~2) 1
Hn	Constant temperature timing	0 : Minute time ; 1 : Hour time ;	(0~1) 0
SPd	Constant temperature deviation	When the "temperature measurement value is more than or equal to the set point of temperature", it is considered to enter the constant temperature state.	(0.1~100.0°C) 0.5
SPT	Constant temperature Prompting time	When entering the constant temperature state, the buzzer prompts the time. Note: when "SPT=9999", it represents a permanent prompt.	(0~9999)0
EST	Timed end Prompting time	When the timing is over, the buzzer promptsthe time. Note: when "EST=9999", it represents a permanent prompt.	(0~9999) 60
EH	Whether to continue the constant temperature control at the end of the timing	0 : Turn off the heating output after timing ; 1 : The constant temperature control is continued after the timing is finished ;	(0~1) 0
ndo		Reserved, invalid.	

oPn	Gate control function	0: Close Gate control function ; 1: Open Gate control function ;	(0~1) 0
nP	Maximum power output	Maximum power percentage of heating output.	(0~100%) 100
Co	Turn off heating output deviation	When the "temperature measurement value \geq the temperature setting value + Co", turn off the heating output. Description: this parameter is valid only when PID is controlled.	(0~100.0°C) 50.0
SPL		Reserved, invalid.	
SPH	Maximum temperature Set value	The maximum value of the set value of the temperature.	(0~100.0°C) 100

Note 1: in order to avoid misjudgment, you should choose the function of closing the door and power off for a system that does not need to open doors or power down

Internal parameter table -3

Parameter indication	Parameter name	Parameter function description	Factory value
Lc	Password	When“Lc=27”, the parameter values can be viewed and modified.	0
Fc	Unit of temperature	0 : degree Celsius ; 1 : Fahrenheit degree ;	(0~1) 0

Internal parameter table -4

Parameter indication	Parameter name	Parameter function description	Factory value
Lc	Password	When“Lc=567”, the parameter values can be viewed and modified.	0
rST	Reset	0 : Cancellation of factory value ; 1 : Confirm the resumption of the factory value ;	(0~1) 0

Digital temperature limiter

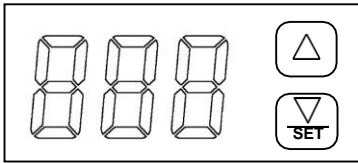

Button function

- 1) **【▲】** : “INC” button. In the setting state, click this button to increase the set value. If you keep pressing this button, the value will increase continuously.
- 2) **【▼/SET】** : “DEC” button. In the setting state, click this button to reduce the set value. If you keep pressing this button, the value will reduce continuously. It has the setting function when modifying internal parameters.

Operation and using

1-1. When the controller is switched on, display window shows the version number for 2 seconds, then it starts running.

1-2. Alarm temperature setting

Under the normal state, window displays temperature alarm set value. Click the “INC” or “DEC” button, the set value starts flashing, at this point, the required temperature alarm setting can be modified through the “INC” and “DEC” button. About 2 seconds after stopping operation, the controller will return to the normal state, the set value will be saved automatically.

1-3. View temperature measurement

In the normal state, press the “INC” and “DEC” button for about 3 seconds, The right decimal point will light up. At this point, the window displays the measured temperature value instead of the alarm temperature setting. Click the “INC” or “DEC” button again, the controller will return to the normal state.

1-4. Over temperature alarm

In the normal state, when the temperature measurement exceeds the alarm temperature setting value, the window alternately displays " - A - " and alarm setting value, the controller will cut off the output automatically, the buzzer beeps.

1-5. Abnormal temperature measurement alarm

If the window shows the prompt “---”, it indicates that the temperature sensor has faults or temperature exceeds the measuring range or the controller itself is faulty, the controller will cut off the output automatically, the buzzer will sound continuously. Please check the temperature sensor and its wiring carefully.

1-6. When the buzzer sounds, press any button to mute

View and set internal parameters

In the normal state, press the “INC” and “DEC” button for about 6 seconds, the window alternately displays "Lc" and password value, the required password value can be modified only by the “INC” button. Then click the “DEC” button, the controller will enter the internal parameters setting state. Press the “DEC” button for 3 seconds, it will return to the normal state, the set value will be saved automatically.

Temperature Limiter parameter table

Prompt	Name	Function description	(Setting range) Factory value
Lc	Password key	When “Lc=3”, enter the next parameters.	0
Pb	Temperature deviation correction	It is usually used to correct errors in low temperature measurement. $Pb = \text{Actual value} - PV$	(-50~50°C)0
PL	Temperature slope correction	It is usually used to correct errors in high temperature measurement. $PK = 1000 \times (\text{Actual value} - PV) \div PV$	(-199~199) 0
SPH	Max set value	The maximum temperature set point value.	(0~400) 400

5. Wiring diagram

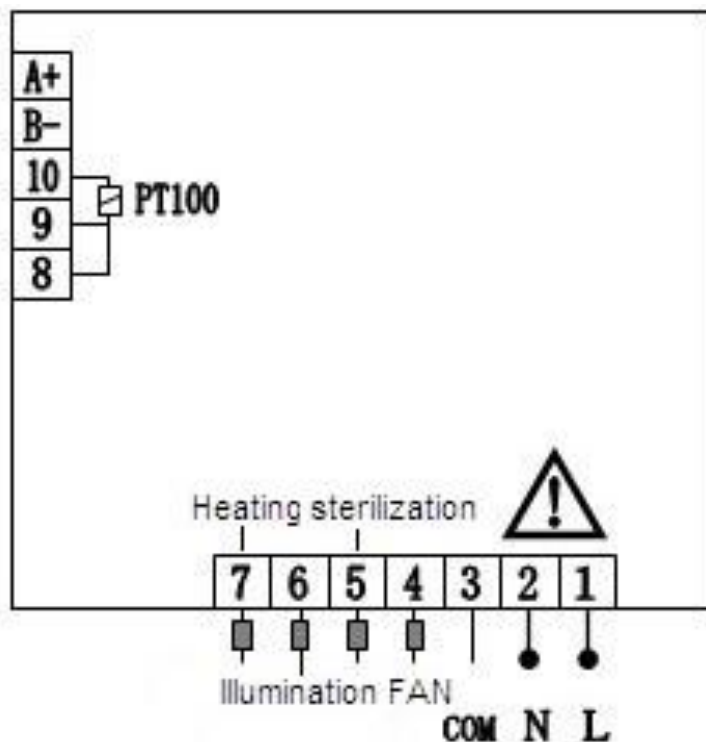

6. General fault and troubleshooting

Failure phenomenon	Fault analysis	Troubleshooting
Temperature control instrument display 0000 or----	<ol style="list-style-type: none"> 1.The sensor is broken 2.Sensor connection shedding 3.The controller is broken 	<ol style="list-style-type: none"> 1. Replace sensor 2. Check the connection and connect firmly 3. Replace controller
The temperature has been rising uncontrolled	<ol style="list-style-type: none"> 1.Controller wiring board is broken 	<ol style="list-style-type: none"> 1.Replace controller wiring board
The circulating fan does not turn or has abnormal sound	<ol style="list-style-type: none"> 1.The motor is broken 2.Controller wiring board is broken 3.Motor fan blade damage 	<ol style="list-style-type: none"> 1. Replace motor 2. Replace controller wiring board 3. Replace Motor fan blade
Setting temperature is greater than measuring temperature. The temperature does not rise	<ol style="list-style-type: none"> 1. The heater is broken 2. Temperature limiting device setting temperature too low 	<ol style="list-style-type: none"> 1. Replace the heater 2. Properly adjust the temperature of the temperature limiter
Overshoot of temperature	Incorrect setting of instrument related parameters	<ol style="list-style-type: none"> 1. Check the instructions for readjustment
The effect of sample culture is inconsistent	<ol style="list-style-type: none"> 1.The sample is placed too much in the studio to lead to poor uniformity 	<ol style="list-style-type: none"> 1.The sample of no more than 80% of the volume.

7. Maintenance

- Proper maintenance can keep instruments working properly and lengthen its lifetime.
- Do not spray cleanser into the instrument when cleaning. Avoid cleaning it with chemical solutions to prevent reaction damage.
- Unplug the power line while cleaning.
- Wear the proper protective gloves during cleaning procedures.
- The device needs to be cleaned and decontaminated before sending to repair.
- Must be sent with the original packing.
- Make sure the device is used on a clean and dry surface and that the ambient temperature is steady.

8. Transport and storage

- Keep the device on a dry and clean place with good airing and free of corrosive gases and flammable or corrosive atmospheres.
- Ensure that the device does not get wet or hit during transport.

9. Technical features

1. There is a fan for breeze circulation in the working room and a large area of mica electric film heating at the bottom so that the temperature of the work chamber is distributed uniformly.
2. Large-screen LCD display, multiple sets of data, one screen display, intelligent PID temperature control system, with PT100 high-precision sensor, high temperature control accuracy.
3. Double door structure, the inner door is made of high-quality stainless steel to facilitate the observation of samples, the outer door is made of magnetic strips, opening and closing is convenient, and the sealing is good.
4. Standard light, germicidal light, breeze circulation fan, 485 communication interface.
5. Independent temperature limiter: imported mechanical temperature limiter, set the work room limit temperature, to provide double safety protection for the product.

Model		INCU-045-001	INCU-065-001	INCU-125-001
Cycle Mode		Breeze circulation		
Function	Temp. Range	RT+5-65°C		
	Temp. Resolution Ratio	0.1°C		
	Temp. Motion	±0.5°C		
	Temp. Uniformity	±0.8°C		
Structure	Inner Chamber	Stainless steel		
	Insulation layer	Polyurethane		
	Heater	Mica electrothermal film		
	Power Rating	0.25kW	0.25kW	0.5kW
	Exhaust hole	φ28mm top (with function of test hole)		
Controller	Temp. control mode	PID Intelligent		
	Temp. setting mode	Touch button setting		
	Temp. display mode	Measuring temperature: LCD upper row Setting temperature: The lower row		
	Timer	0-9999 min (with timing wait function)		
	Operation function	Fixed temperature operation, timing function, auto stop.		
	Sensor	PT100		
Safety device		Mechanical independent temperature limiter,		
Specification	Inner Chamber size(W*L*H)(mm)	350*350 *350	400*350 *450	500*450 *550
	Exterior size (W*L*H)(mm)	525*480 *620	575*480 *720	675*580 *820
	Packing size (W*L*H)(mm)	605*572 *775	655*572 *875	755*672 *975
	Volume	45L	65L	125L
	Shelf number	7	9	13
	Load per rack	15kg		
	Shelf space	35mm		
	Supply(50/60HZ)Current rating	AC220V / 1.1A	AC220V / 1.1A	AC220V / 2.3A
	NW/GW (kg)	27/30	32/35	45/49
Accessory	Shelf	2		
	Shelf frame	4		

Nota importante para los aparatos electrónicos vendidos en España

Instrucciones sobre la protección del medio ambiente y la eliminación de aparatos electrónicos:



Los aparatos eléctricos y electrónicos marcados con este símbolo no pueden ser eliminados en forma de residuos urbanos.

De conformidad con la Directiva 2012/19/UE, los usuarios de la Unión Europea de aparatos eléctricos y electrónicos, tienen la posibilidad de devolver sus RAEE para su eliminación al distribuidor o fabricante del equipo después de la compra de uno nuevo. La eliminación ilegal de aparatos eléctricos y electrónicos es castigada con multa administrativa.

Remarque importante pour les appareils électroniques vendus en France

Informations sur la protection du milieu environnemental et élimination des déchets électroniques :



Les appareils électriques et électroniques portant ce symbole ne peuvent pas être jetés dans les décharges.

En réponse à la réglementation, Labbox remplit ses obligations relatives à la fin de vie des équipements électriques de laboratoire qu'il met sur le marché en finançant la filière de recyclage de ecosystem dédiée aux DEEE Pro qui les reprend gratuitement (plus d'informations sur www.ecosystem.eco).

L'élimination illégale d'appareils électriques et électroniques est punie d'amende administrative.

Nota importante per le apparecchiature elettroniche vendute in Italia

Istruzioni sulla protezione ambientale e sullo smaltimento dei dispositivi elettronici:



Le apparecchiature elettriche ed elettroniche contrassegnate con questo simbolo non possono essere smaltite come rifiuti urbani.

In conformità con la Direttiva 2012/19 / UE, gli utenti dell'Unione Europea di apparecchiature elettriche ed elettroniche hanno la possibilità di restituire i propri RAEE per lo smaltimento al distributore o al produttore di apparecchiature dopo averne acquistato uno nuovo. La rimozione illegale di apparecchiature elettriche ed elettroniche è punibile con una sanzione amministrativa.

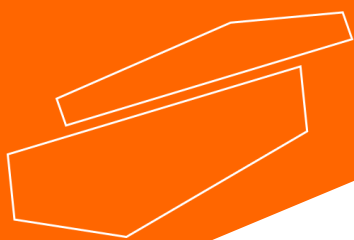

www.labbox.com