

# USER MANUAL

---

## D1524R Tabletop High-speed Refrigerated Micro Centrifuge



This user manual needs to be read before operating this product.  
Please follow the safety instructions provided in this manual.

## Table of Contents

Safety Warnings .....	3
1. Performance indicators.....	5
2. Conformity to standards .....	5
3. Environmental conditions .....	5
3.1. Basic operating conditions .....	5
3.2. Transport and storage conditions .....	6
4. Installation.....	6
4.1. Mounting position.....	6
4.2. Connection between power cable and ground wire.....	7
5. Structure.....	7
6. Operating panel.....	8
7. Rotor preparation.....	10
7.1. Prepare the samples to be separated .....	10
7.2. Place samples into the centrifuge tube.....	10
7.3. Ensure the balanced centrifuge tube .....	10
7.4. Check the rotor.....	11
7.5. Insert the centrifuge tubes symmetrically onto the rotor in place without imbalance.....	11
8. Operation .....	11
8.1. Normal operation .....	11
8.2. RCF operation.....	15
8.3. Transient operation.....	16
9. Maintenance and servicing .....	16
9.1. Cleaning.....	16
9.2. Sterilization.....	17
9.3. Wearing parts.....	18
9.4. Replacement of rotor seal.....	18
9.5. Routine check.....	19
10. Common failures and solutions.....	19
10.1. List of common failures.....	19

10.2. How to open the outer lid.....	20
10.3. Replace the fuse.....	21
11. Introduction to rotor and centrifuge tube.....	21
11.1. Rotor description.....	21
11.2. Centrifuge tube.....	23
12. RCF calculation.....	24
13. Ordering information.....	25
14. Warranty.....	25
14.1. Unit warranty.....	25
14.2. Rotor warranty.....	25
15. After-sales services.....	26

# Safety Warnings

The symbol  is an internationally accepted safety mark. Please carefully read and fully understand the following safety rules:

- Comply with the operation requirements contained herein and ensure safe operation.
- Carefully read all safety information and reminders provided in this manual.
- Safety information is marked as follows. The safety symbol  is combined with the “Warning” and “Caution” respectively, reminding users of the potential danger. These two combinations and the “reminder” symbols are defined as follows:



Warning: personal danger.

Warning against potential dangers, which might result in injury or death if the requirements contained herein are not strictly complied.



Caution: Potential danger to instrument

Ensure to comply with all the safety requirements as mentioned to avoid potential dangers of damage to the instrument

Reminder: matters that generally call for attention.

- Do not use this centrifuge in any manner not mentioned in this user manual.
- In case of any problem, please contact the vendor/supplier.
- This user manual provides complete details of the potential dangers, however users are advised to stay alert against unpredictable circumstances and use this centrifuge with care.



**Warning:**

- This centrifuge is non-explosion proof and may not be used for separation of flammable or explosive samples.
- Do not install this centrifuge in the vicinity of any flammable gas or chemical substances.
- Do not place anything that causes danger within 30cm radius of this centrifuge.
- Don't centrifuge any toxic, radioactive or pathogenic organisms without appropriate safety measures. If the microorganism sample being centrifuged is secondary hazard (as defined in the WHO's "Laboratory Biosafety Manual"), ensure to use biological sealing devices.
- Ensure to sterilize it according to decontamination procedures that are mentioned under sterilization section.
- If there is any need for onsite assistance, sterilize and decontaminate the centrifuge in advance and notify

the service representative about the details.

- Never touch the power cable/switch with wet hands and avoid electric shocks.
- As a safety measure, ensure to maintain at least 30cm distance from the centrifuge while in operation.
- For safety reasons, when the centrifuge is running, the personnel should maintain a 30cm distance from the centrifuge.
- Never open the outer lid while the rotor is in operation.
- The centrifuge should be opened for repair/ dismantling by trained staff only.



## Caution

- Ensure that the centrifuge is stable, before its operation.
- Ensure that the angle between the outer lid and housing is larger than 90° while opening the lid.
- Never place hands/any other things in between the outer lid and the housing.
- Never open the outer lid while the centrifuge is in operation.
- Don't move or lean against the centrifuge if it is in operation mode.
- If there is any liquid found in the centrifuge, ensure to wipe it OFF with a cloth in time to prevent sample contamination.
- Ensure that the centrifuge chamber is left clean and free of any foreign objects/ tube fragments before each and every operation
- Reminders about rotor:
- Check and ensure that the rotor surface is free of corruptions/ damages before its operation.
  - (1) The set rotation speed of the centrifuge should not exceed the allowed minimum speed of the rotor assembly and accessories (rotor and adapter) and ensure to run the centrifuge under minimum allowed speed.
  - (2) Don't exceed the allowed amount of imbalance.
  - (3) The centrifuge tubes used should be within their allowed capacity.
  - (4) If the rotor has a lid, ensure to tighten it before operation.
  - (5) Use genuine accessories only.
- If there is any abnormality or strange noise observed in operation, please stop the centrifuge operation and contact the service center and intimate the failure code immediately.
- Earthquake might cause damage to the centrifuge. If any abnormality occurs, please contact the service center.

# 1. Performance indicators

Maximum rotation speed	15,000rpm (200-15,000rpm) step: 100rpm
Maximum relative centrifugal acceleration	21,380×g, step: 10×g
Capacity	1.5/2ml×24; 0.5ml×36; PCR8 tube bank ×4; 5ml×12; 5ml×18;
Temperature setting range	Tabletop high-speed refrigerated micro-centrifuge: -20°C- 40°C
Timing	30s-99 min; HOLD (continuous running)
Drive motor	DC brushless motor
Safety performance	Dual door locks, overspeed, overtemperature and Internal diagnosis system.
Power	Single phase 220-230V, 5A, 50/60Hz, 400W 110-120V, 5A, 50/60Hz, 490W
Dimensions (mm)	(Width) 332× (depth) 553× (height) 283
Weight	30kg
Acceleration and deceleration time	25s↑25s↓
Noise	≤56dB
Other functions	Rotation speed/RCF switchover, inching operation, running process indication and sound reminder; 9-step acceleration, 9-step deceleration; stored program capability.

# 2. Conformity to standards

The centrifuge's structure conforms to the following safety standards:

IEC 61010-1:2010,

AMD1: 2016/EN 61010-1:2010,

UL 61010-1:2012 R4.16 and CAN/CSA-C22.2 NO.61010-1-12+ GI1+GI2

CB Scheme N/A

EN 61010-2-020

The centrifuge's structure conforms to the following electromagnetic compatibility standard:

EN 61326-1

Compliant with the following EU standards:

EMC standard: 2014/30/EU

# 3. Environmental conditions

## 3.1. Basic operating conditions

(1) Power supply: single phase, 220-230V, 5A, 50/60Hz, 400W or 110-120V, 5A, 50/60Hz, 490W

- (2) Ambient temperature: 2~40°C.
- (3) Relative humidity: ≤80%.RH
- (4) No vibration or air flow present nearby that might affect performance.
- (5) No conductive dust, explosive gas or corrosive gas exists in ambient air.

## 3.2. Transport and storage conditions

- (1) Range of ambient temperature: -40°C-55°C.
- (2) Range of relative humidity: ≤93%.RH
- (3) The centrifuge must remain upright while in transit, suitably protected using wooden Kart box
- (4) Lift the centrifuge by the chassis only.
- (5) Pay attention to the centrifuge's weight while in transit (see the “performance indicators”).
- (6) Centrifuges with cooling device, should be left for about 1hour after being relocated to a new position to stabilize the refrigerant in the compressor

## 4. Installation

Users must strictly comply with the installation instructions contained in this chapter.

Be advised! Remove the rotator before moving the centrifuge.

### Warning

- Improper power connection might damage the centrifuge.
- Before connecting the power supply, please check the power supply for compliance with the requirements.

### 4.1. Mounting position

- (1) This centrifuge must be mounted on a solid, flat and tabletop with contact between the four feet of the centrifuge and the tabletop. Don't mount the centrifuge on any sliding tabletop, otherwise significant vibration might occur. Carefully place the centrifuge to avoid damage.
- (2) The ideal ambient temperature is 20°C ±5°C and the ambient temperature should not be more than 30°C. Avoid direct sunlight on this centrifuge.
- (3) Place the centrifuge at >30cm distance from the wall and other instruments if using multiple units together to ensure effective cooling.
- (4) Ensure that there is no water leakage/ heat loss near the centrifuge as it may cause the rise in temperature and thereby leading to centrifuge failure.

## 4.2. Connection between power cable and ground wire

 Warning

- Don't touch the power cable with wet hands and avoid electric shocks.
- Ensure that the centrifuge is well grounded.

(1) This centrifuge uses three-core power cable and three-core flat plug, the latter of which may be directly connected to the power socket.

(2) Ensure that the centrifuge is protected by good grounding terminal and that the label on it indicated the correct voltage (>10A) before connecting the device to power supply.

## 5. Structure

### D1524R

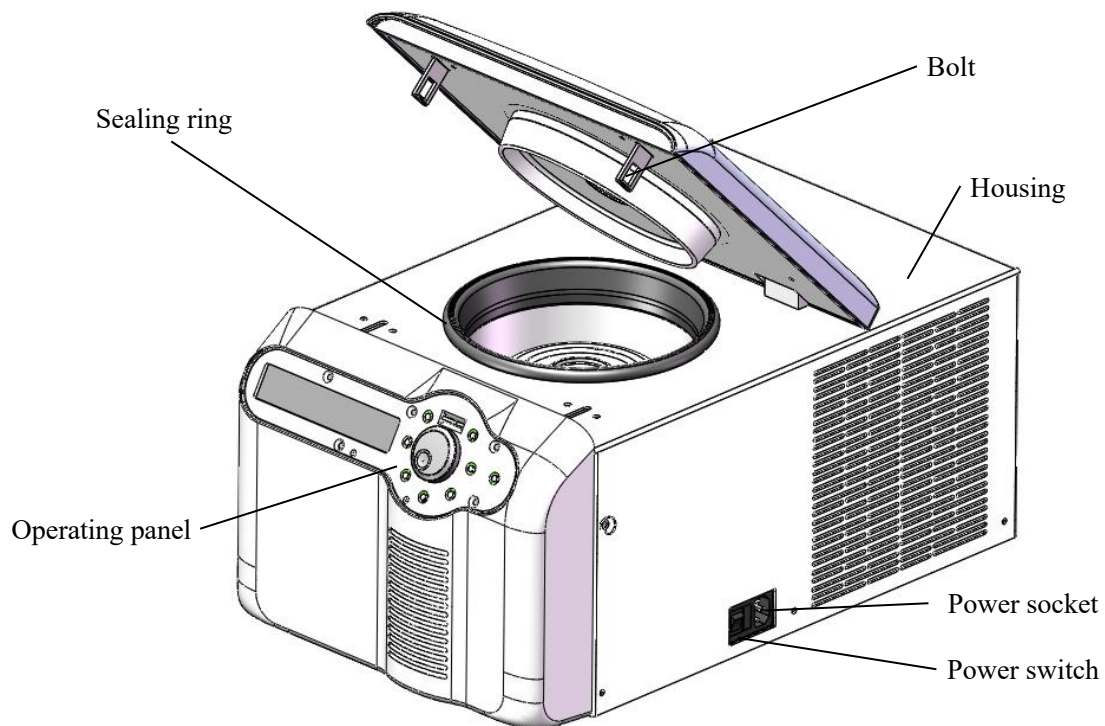

Fig. 5.3. Front view of centrifuge



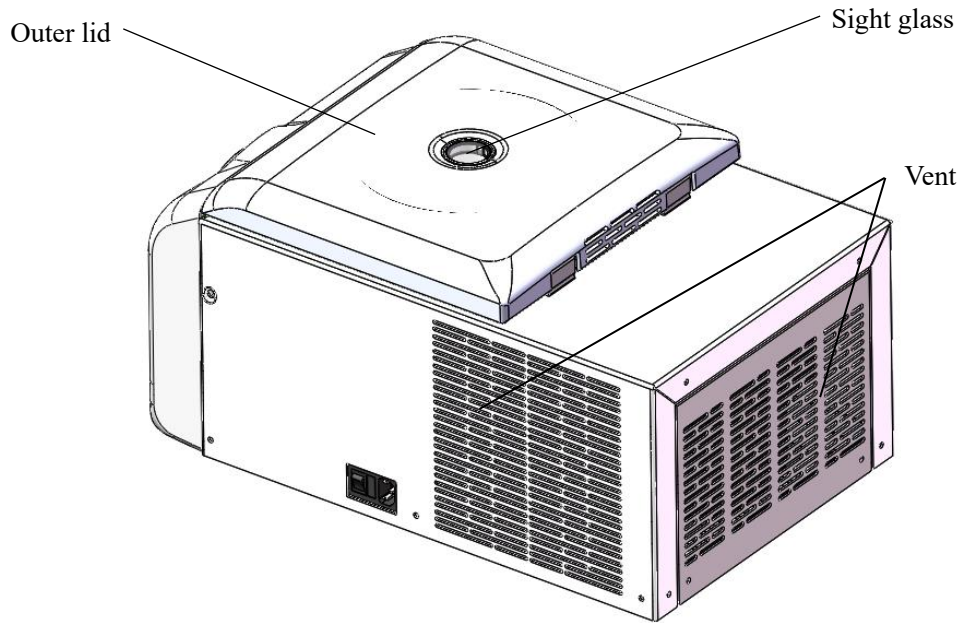

Fig. 5.4 Rear view of centrifuge

## 6. Operating panel

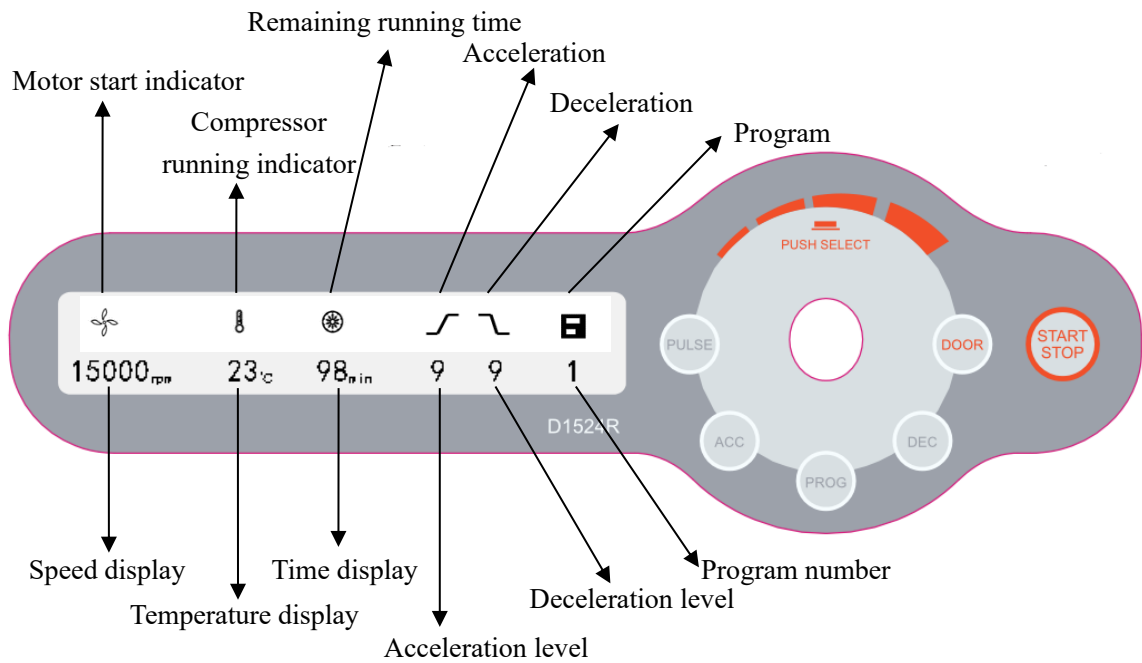









Fig. 6.1 Schematics of operating panel

No.	Legend	Name	Function
1		Acceleration level adjustment+ key	Press this key to increase the speed level by 1; acceleration level 1-9 cycle.
2		Deceleration level adjustment+ key	Press this key to decrease the speed level by 1; deceleration level 1-9 cycle.
3		Program key	Press this key to switch to the stored program +1, stored program, program 0-9 cycle.
4		Door lock open key	When the speed is zero, press this key to release the door lock. When the speed setting is above zero, the door locks automatically.
5		Inching key	When the outer lid is locked tightly, by pressing and keeping this key, the centrifuge runs up to the set rotation speed. Press and hold this key
6		Running/stop key	When the speed is zero, press this key to start run operation While the centrifuge is operating, press this key to stop its run.
7		Parameter input key	Turn this key clockwise to increase the parameter; turn this key counterclockwise to decrease the parameter. Press this key to choose the speed setting, centrifugal force setting, temperature setting and time setting.

The following table provides comparison between acceleration and deceleration time in 1-9 positions:

(error  $\pm 10\%$ )

Position	Acc (0—15,000rpm)	Dec (15,000-0rpm)
1	75s	73s
2	52s	44s
3	44s	42s
4	35s	38s
5	30s	36s
6	28s	34s
7	26s	31s
8	24s	28s
9	23s	26s

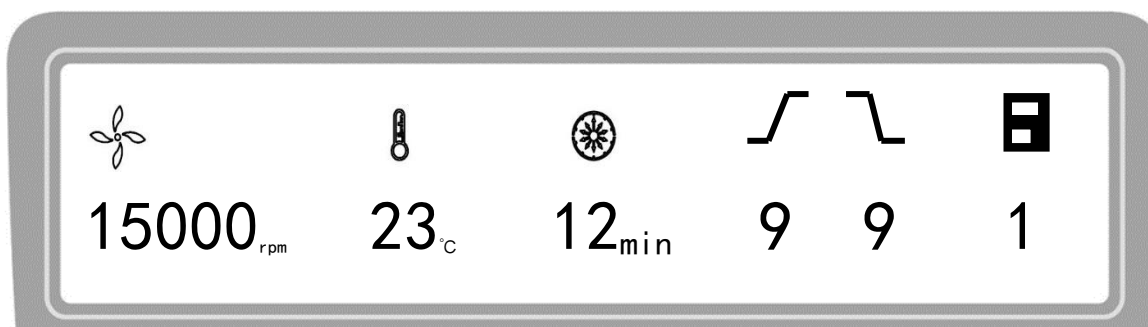





Fig. 6.2 Schematics of main display

The D1524R main display is shown in Fig. 6-2. At this time, the speed is set at 15,000rpm, indicating the presumed sample temperature of 23°C and the set running time of 12 min.

When the speed icon  rotates, it indicates that the machine is in run mode.

The temperature display icon  indicates three states: when it is lit ON, it indicates the presumed sample temperature; when it is OFF, it indicates the set temperature; when it flashes, it indicates the compressor starts refrigerating to control the temperature of the centrifugal chamber.

The time display icon  divides the entire running time into 10 equal parts, displaying the ratio of elapsed time to the total time.

## 7. Rotor preparation

### 7.1. Prepare the samples to be separated

### 7.2. Place samples into the centrifuge tube

The amount of sample should not exceed the allowed maximum amount set forth in this user manual.

 Caution: Adding excessive samples into the centrifuge tube will result in leakage, therefore don't add excessive samples.

### 7.3. Ensure the balanced centrifuge tube

- Although this centrifuge may be used with visually confirmed balance, it is suggested that samples be weighed using a balance to ensure balanced centrifuge tube in order to prolong the service life

of centrifuge.

- Although the partial imbalance is allowed, don't run this centrifuge under poor balance conditions.

## 7.4. Check the rotor

Check the rotor for any corrosion or scratch before use

 Caution:

- Avoid using the rotor with scratches or corrosion.
- Never use the rotor of other brands/ specifications on this centrifuge.
- Do not expose the rotor and its accessories to direct sunlight/Ultraviolet.

## 7.5. Insert the centrifuge tubes symmetrically onto the rotor in place without imbalance

 Caution:

- Ensure to tighten the rotor to the main shaft firmly and the lid is secured properly on the rotor. Otherwise, the rotor might fall OFF while the centrifuge is in operation, resulting in centrifuge or rotor damage.
- Tighten the rotor lid and rotor firmly.

# 8. Operation

## 8.1. Normal operation

When the power switch is turned ON, the display screen is lit and the centrifuge shows HELLO page, as shown in Fig. 8-1.

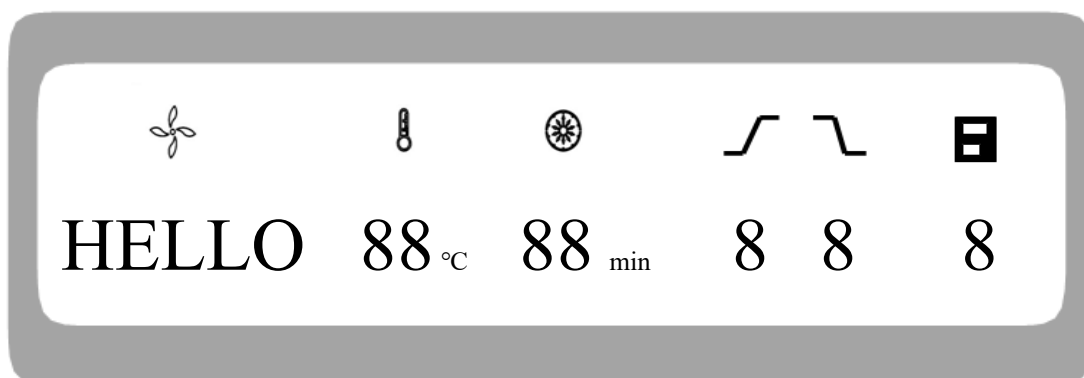

Fig. 8-1. Self-test page of centrifuge

The centrifuge shows the centrifuge model 1524R and program version 1.0, as shown in Fig. 8-2.

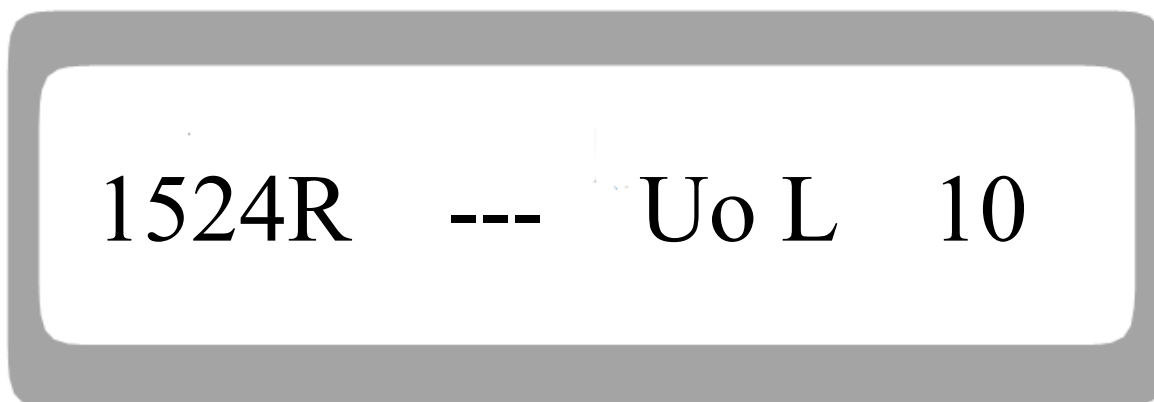

Fig. 8-2 Model and version interface

Then, the centrifuge displays the last operating parameters, as shown in Fig. 8-3.

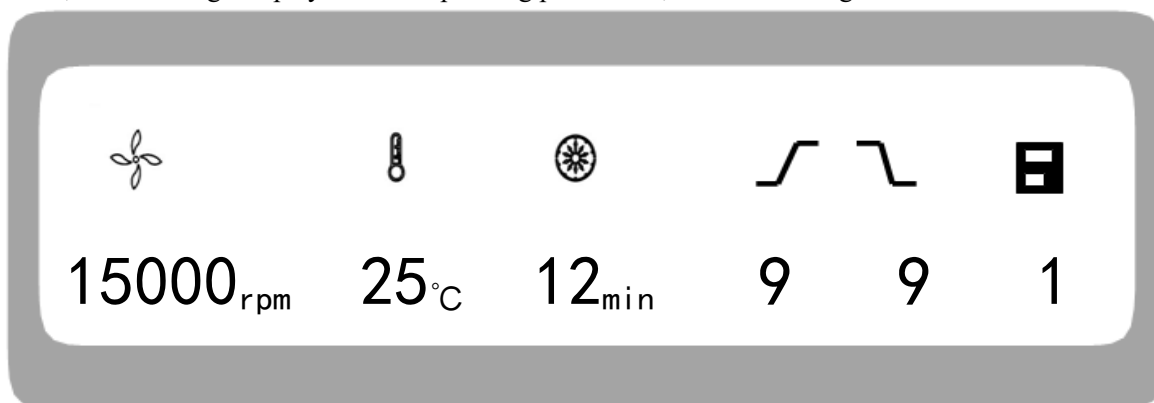
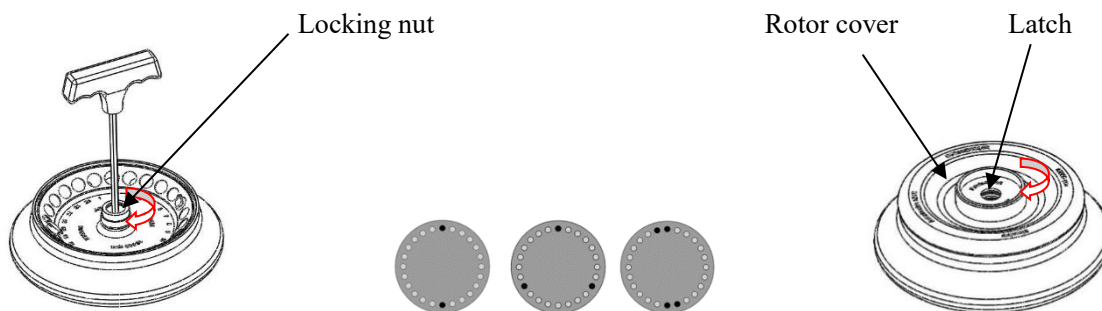

Fig. 8-3. Last operation interface

- Speed set at 15000rpm, time set at 12 min and centrifugal chamber temperature 25°C.
- The outer lid lock is released.

### 8.1.1. Rotor installation and replacement



**Mount the rotor on the main shaft**

**Mount the tubes symmetrically**

**Mount the rotor cover.**



Fig. 8-4. Rotor installation

**⚠ Caution**



- Place the rotor on the main shaft and ensure full contact between the rotor and the main shaft. Screw up the nut on the rotor tightly using a wrench to connect the rotor with the main shaft firmly, otherwise the rotor might fall OFF, causing damage to the centrifuge.
- Tighten the rotor and the lid firmly.

- When placing the rotor, ensure the full contact between the rotor and the main shaft.
- After placing the rotor in place, rotate the rotor gently with hands to check for normal operation of the rotor. Check and adjust the rotor position once again.
- Rotate the locking nut clockwise using the rotor wrench and tighten the rotor and main shaft firmly.
- Place the rotor lid and rotate it clockwise to screw the rotor tightly. Close the outer lid and run the centrifuge.
- The rotor is dismantled in a manner opposite the aforesaid, with the tightening direction being counterclockwise.



### 8.1.2. Set operating parameters

The parameter key  is used to input and modify the operating parameters. Press the parameter key  gently so that the centrifuge enters into adjustment mode. Press and select the parameter to adjust its value to desired setting. Adjust the values only when the required parameter icon flashes. The minimum rotation speed is 100rpm, the minimum step of centrifugal force is 10g and the minimum step time is 1second if within 1 minute and if not it is 1 minute.



- (1) Set the rotation speed

- Press the parameter key  to choose the rotation speed parameter value in rpm.
- Set the speed value to desired setting when it enters into the adjustment mode and flashes.
- The minimum set speed is 200rpm, and the minimum step is 100rpm.
- The parameter increase or decrease is cyclic. Turn the parameter key  clockwise or anticlockwise to increase or decrease the adjusting parameter values.

(2) Set the run time

- Press the parameter key  to select the time parameter and wait until its value flashes.
- Set the time parameter value to desired setting within the range of 10s-99min.
- Turn the parameter key  to input the set time within a range of 10 s-99min.
- When the time enters HD, it indicates that the instrument is in continuous run mode.

(3) Set the operating temperature



- Press the parameter key  to set the temperature and wait until its value flashes.
- Turn the parameter key  to adjust the temperature within a range of -20°C ~ 40°C.
- When the temperature icon  flashes, it means the refrigerating system is working, otherwise the refrigerating system is not working.

### 8.1.3. Start Run

(1) Press the  key to start operation.

- The rotor starts rotating.
- Timer starts to operate after the instrument reaches the set rotation speed only.
- The screen displays the actual time left to complete the running operation.

(2) Inquire and change the operating parameters

- The operating parameters can be modified after the centrifuge operates at a steady speed.
- Press the parameter key  to return to ready mode interface with set operating parameters.
- Press the parameter key  gently and required parameter to modify the set values.
- After 7 seconds of no activity, the centrifuge will return to the normal operating state with the new operating parameters.
- In case if there are any changes in the operation time setting, the elapsed time will not be zeroed.

(3) Error message

- The centrifuge will automatically stop if any failure occurs in the run mode, with the failure code indicated on the time display window. By looking up table 10-1, the cause of failure can be found and appropriate action should be taken.

#### 8.1.4. Stop running

(1) When the set run time is completed the centrifuge stops its run operation automatically or it can

be stopped by pressing the  .

(2) The outer lid lock is opened.

- The centrifuge beeps when the rotor ceases to rotate, indicating that the operation is over.
- After the end of operation, the outer lid lock on the centrifuge remains closed and the outer lid



lock should be opened by pressing  key. Open the outer lid to remove the samples and rotor.

- The centrifuge will automatically retrieve the last set parameters as soon as it is switched ON.

## 8.2.RCF operation

Turn power switch ON and Set the RCF (relative centrifugal force).

<p> Caution</p> <ul style="list-style-type: none"> <li>● The relative centrifugal force set should not exceed the maximum relative centrifugal force allowed by the centrifuge tube and its adaptor.</li> <li>● The relative centrifugal acceleration is calculated based on the maximum centrifugal radius and operating speed of the rotor. (See Table 11.1 for the maximum centrifugal radius).</li> </ul>
--

- Press the parameter key  to choose the rotation speed unit as  $xg$ . If the RCF value flashes it indicates that the RCF value can be set as it is in adjustment mode.
- Turn the parameter key  to adjust the relative centrifugal acceleration, in increments of  $100xg$ .
- The instrument will automatically enter into ready mode from adjustment mode, if it is left inoperated for more than 7seconds.

Set the operating conditions



See Section 8.1 for operation of other parts.



## 8.3. Transient operation

This function is generally used to remove the samples attached to the inner wall of the centrifuge tube.

Reminder: this key works only when the rotor is inactive and the outer lid is locked firmly.

- (1) Turn power switch ON, fix the rotor on the main shaft and secure tightly with the rotor lid.
- (2) Close the outer lid.
- (3) The centrifuge enters into ready mode and displays the last operated parameter values.
- (4) Press and hold the  key down to increase and set the rotation speed.
- (5) Release the  key to start decelerating and shutdown.

## 9. Maintenance and servicing

### 9.1. Cleaning

 Caution

- Disconnect the power supply before cleaning the centrifuge.

#### (1) Centrifuge

- The color of housing might change and the label thereon might fall OFF if the centrifuge is exposed to ultraviolet for a prolonged period of time and hence cover the centrifuge with cloth to avoid exposure to light.
- Clean the centrifuge using a cloth/ sponge soaked with neutral cleansing agent in case if it is dirty after use
- The centrifuge can be sterilized using cloth soaked with 70% alcohol solvent.

#### (2) Centrifugal chamber

 Caution

- Never pour water or other solvents directly into the centrifugal chamber as they might enter into the drive unit and cause corrosion or damage to the bearings.

#### (3) Drive shaft

- It is suggested that the drive shaft be subjected to periodical maintenance by wiping it using soft cloth and applying a thin layer of silicone grease on it.

#### **(4) Outer Lid**

- Clean or sterilize the outer lid in the same manner as mentioned under subsection (1) centrifuge.

#### **(5) Rotor**

- If the rotor is left unused for a prolonged period of time, remove the rotor and its lid from the centrifugal chamber, and place the rotor upside down to dry the rotor hole and prevent corrosion.
- Clean the rotor using mild detergent with PH value of 6-8 and immediately dry the aluminum portion after cleaning by putting it into a warm-air dryer at a temperature not exceeding 50°C.

#### **(6) Drainage**

- D1524R is equipped with drainage slots, which need to be drained when a substantial amount of water is accumulated in those slots.

## **9.2. Sterilization**

If the centrifuge tubes contain infectious materials leaks, you must immediately sterilize the rotor and/or centrifuge.

- Infectious substances might enter the centrifuge if the centrifuge tube breaks or is overfilled.
- Danger of infection might occur through contact. Personnel shall be provided with suitable protective measures.
- Be aware of the allowed filling volume and loading limit of the centrifuge tubes.
- When contamination occurs, the operator must ensure that others are not endangered.
- The contaminated portion must be sterilized immediately.
- Take further protective measures if necessary.

### **9.2.1. Sterilize using common neutral sanitizers**

The rotor and the centrifugal chamber must be treated with common neutral sanitizers. The most suitable way is to spray the spray-type sanitizer evenly over the rotor and accessories.

Sterilize the rotor and accessories as follows:

- (1) Disconnect the power supply.
- (2) Unscrew the rotor from the rotating shaft.
- (3) Remove the rotor and pull it up vertically from the rotating shaft.
- (4) Take out the centrifuge tubes and adaptors and sterilize or dispose of them when necessary.
- (5) Treat the rotor and rotor lid (soaking or spraying) according to the sanitizer instructions.
- (6) Drain the sanitizer by turning the rotor upside down and then flush it with water.
- (7) Remove the residual sanitizer in an effective way.
- (8) The aluminum rotor must then be treated with anti-corrosion oil.

- (9) All sealing rings must be re-lubricated.

### 9.2.2. Sterilize using bleaching alkali liquor

 Caution

Bleaching alkali liquor contains highly concentrated erosive hypochlorite, therefore it may not be used for aluminum rotor.

The following are the protective measures for plastic rotor:

- (1) Avoid high temperature and ensure the temperature of bleaching solution and rotor is not more than 25°C.
- (2) Do not bleach longer than necessary!
- (3) After sterilization, flush the rotor thoroughly with distilled water and dry it.
- (4) All sealing rings must be re-lubricated.

## 9.3. Wearing parts

Please replace the below wearing parts in time according to the suggestions in the following table or whenever it is necessary.

No.	Wearing part	Replacement conditions
1	Rubber seat of temperature sensor	Crack
2	Sealing ring of centrifugal chamber	

## 9.4. Replacement of rotor seal

### 9.4.1. Introduction

Three rubber rings are used in order to achieve biological sealing, as shown in the following figure. After multiple autoclaving runs, the rubber rings might age or fall off and need to be replaced or remounted.

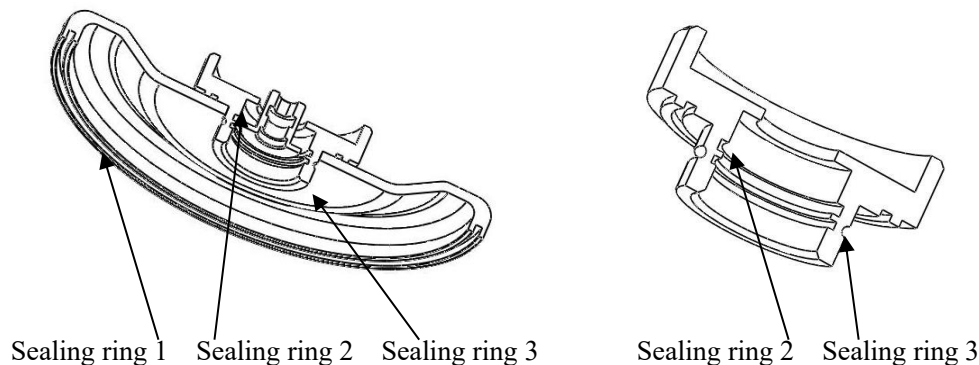

Fig. 9-1 Rotor sealing ring

### 9.4.2. How to replace

- (1) Clean the rubber ring groove using neutral cleaning solution before air drying it.
- (2) Apply glue evenly inside the rubber ring groove before placing the rubber ring into its groove and evenly pressing it to make the rubber ring contact with the groove bottom and firmly adhered.
- (3) Leave it for 20 min and wait for the glue to completely solidify.

## 9.5. Routine check

- (1) Ensure that the centrifuge is placed on a solid, level and flat table top surface and ensure that 3/4<sup>th</sup> of it is on the table surface.
- (2) Ensure that the machine is reliably grounded: using a multi-meter, check whether the grounding pin in the power cable plug and the centrifugal chamber and motor shaft are short-circuited. In case of short-circuit, it indicates reliable grounding. In case of disconnection, identify the causes and eliminate the failure before the centrifuge operation.

# 10. Common failures and solutions

## 10.1. List of common failures

This centrifuge is capable of self diagnosis. When the centrifuge fails, the time display window will indicate the failure code, leading to the immediate identification of possible failure causes.

Phenomenon		Possible cause	Solution
No display after power ON		<ul style="list-style-type: none"> <li>· No power supply to the power socket.</li> <li>· Fuse burned out.</li> </ul>	<ul style="list-style-type: none"> <li>· Eliminate the failure and reconnect the power supply.</li> <li>· Replace the fuse.</li> </ul>
Alarm code indicated on the time display	E-02 Outer lid failure	<ul style="list-style-type: none"> <li>· The door opens while in operation.</li> <li>·  is pressed when the door is opened.</li> </ul>	<ul style="list-style-type: none"> <li>· Immediately close the cover.</li> <li>· Close the outer lid before operation.</li> </ul>
	E-04 Temperature abnormality	<ul style="list-style-type: none"> <li>· The housing vent might got blocked.</li> <li>· The cooling fan might got damaged.</li> </ul>	<ul style="list-style-type: none"> <li>· Unblock the vent.</li> <li>· Replace the cooling fan.</li> </ul>

	E-06 Abnormal rotation speed setting	·Change the set rotation speed value.	·Change the set rotation speed value.
	E-10~86	·Check the service manual.	·Contact the service representative.

Table 10-1 Common failures and solutions

- Failure code E-1~E-6 is related to erroneous operation. The centrifuge may continue running after elimination of the failure.

## 10.2. How to open the outer lid

### 10.2.1. When turned ON

Reminder: When the centrifuge is switch power ON, open the outer lid only when the rotor is not running.

- (1) When the centrifuge is turned ON, the outer lid opens automatically.
- (2) At the end of centrifuge operation, the outer lid remains locked.
- (3) When the rotor stops, press  key and unlock the outer lid and one can observe that the lid can be opened now.

### 10.2.2. When power is OFF

When the outer lid cannot be opened in case of unexpected power failure, the outer lid may be opened as follows:

- (1) Check whether the rotor is in run mode.
  - Listen carefully to ensure that there is no rotation sound.
- (2) Insert a wrench into the housing hole to open the outer lid lock.
  - The hole is located above the front end of the right side panel.
  - Insert the wrench into the right hole to push forward and rotate  clockwise to open the outer lid lock and then the lid.

## 10.3. Replace the fuse

(1) The D1524R centrifuges fuse is 250V, 10A, fast-acting, size:  $\Phi 5 \times 20$ , one fuse.

(2) The centrifuges 250V, 10A fuse is on the power socket. It may be replaced by taking the fuse box out of the power socket; 250V, 3.15A fuse is on the circuit board, It may be replaced by taking the fuse box out of the circuit board.

# 11. Introduction to rotor and centrifuge tube

### Caution

- Carefully read the user manual and correctly install and use the rotor correctly.
- Don't exceed the maximum allowed speed of the rotor, test tube and adaptor. The maximum allowed speed by certain adaptors is lower than the maximum speed of the rotor and check before operation.

## 11.1. Rotor description

### 11.1.1. Rotor structure

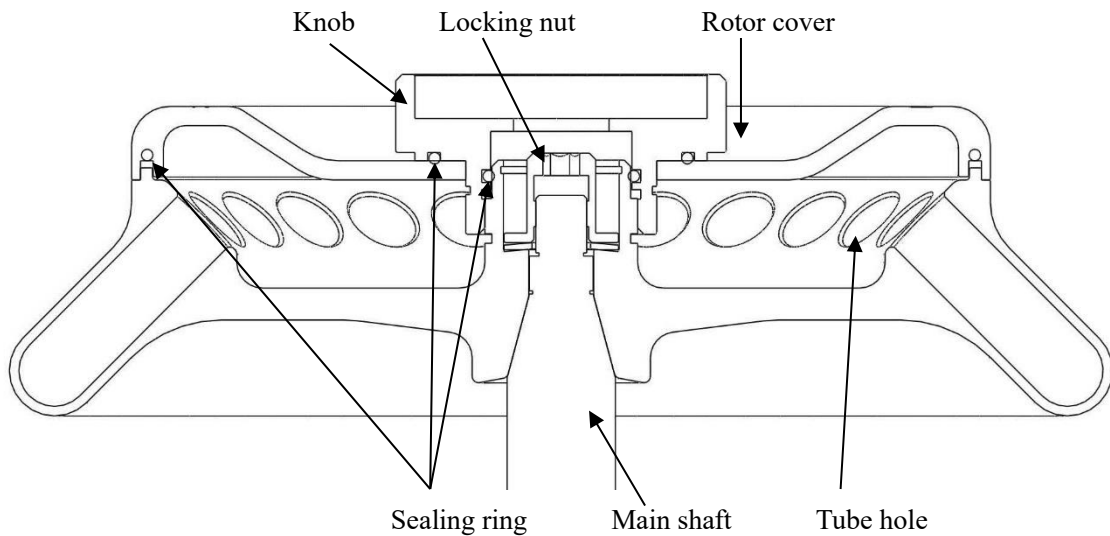

Fig. 11-1 Rotor structure

### 11.1.2. Rotor and adaptor

All rotors are bio-sealed such that centrifuge tube is sealed inside the rotor and when the rotor lid and rotor are secured tightly to ensure no sample leakage during the centrifuge operation. While the rotor lid is not used, the rotor will be incapable of bio-sealing. The rotors and adaptors which are suitable for use with this centrifuge are listed as follows:

Table 11.1 List of rotors and adaptors

Rotor number	Rotor name	Centrifuge tube	Adaptor	Maximum speed (rpm)	Maximum centrifugal radius $r_{max}$ (cm)	Maximum relative centrifugal force RCF ( $\times g$ )
1	AS24-2	2/1.5mL centrifuge tube		15000	8.5	21380 (program correspondence)
		0.2mL PCR tube	A02P2	15000	6.9	17350
		0.5mL micro-tube	A05P2	15000	7.6	19100
2	AS36-05	0.5mL micro-tube		15000	8.5	21380 (program correspondence)
		0.2mL PCR tube	A02P05	15000	7.6	19100
3	AS4-PCR8	PCR8 tube bank		15000	6.5/7.2	16350/18100
4	AS12-V5	5mL conical tube		15000	8.5	21380
5	AS18-5	5mL culture tube		15000	8.5	21380

### 11.1.3. Precautions

(1) The density of sample that the centrifuge rotor can separate is less than 1.2g/ml. If the density of sample to be separated exceeds 1.2g/ml, please calculate the allowed rotation speed using the following formula:

$$\text{Allowed rotation speed (rpm)} = \text{maximum rotation speed} \times (1.2 \text{ (g/ml)} / \text{sample density (g/ml)})^{1/2}$$

(2) If the rotor is left unused for long time, please remove the rotor from the centrifugal chamber, remove the rotor lid and place the rotor upside down to dry the rotor hole and prevent corrosion.

(3) If any sample leaks into the rotor hole, flush the rotor hole with clean water and apply a thin layer of silicone grease on the rotor surface after it dries up.

(4) It is suggested that the rotor to be cleaned once in every three months to ensure cleanliness of the tube hole and main shaft hole before applying a thin layer of silicone grease.

### 11.1.4. Autoclaving

This rotor is made of high-strength aluminum alloy and may be autoclaved at 121°C (1.0kg/cm<sup>2</sup>) for 20 min.

### 11.1.5. Bio-sealing

The rotor of this device employs bio-sealed structure and uses three high-temperature-resistant

rubber rings for sealing. After multiple autoclaving runs, the rubber rings might age or *fall off* and need to be replaced or remounted using the method detailed in 9.4.

## 11.2. Centrifuge tube

### 11.2.1. Please clean and sterilize the centrifuge tube by reference to the following table.

Table 11.2 Conditions for cleaning and sterilization of centrifuge tube      O: Yes    X: No

Condition		Material	PA	PC	PP
Cleaning	Fluid cleaning	Acidic cleaning agent (pH5 or lower)	X	X	X
		Acidic cleaning agent (above pH5)	O	O	O
		Alkaline cleaning agent (above pH9)	O	X	O
		Alkaline cleaning agent (pH9 or lower)	O	O	O
		Neutral cleaning agent (pH7)	O	O	O
		70°C hot water	O	O	O
	Ultrasonic cleaning	Neutral cleaning agent (pH7)	O	O	O
Sterilization	Autoclaving	115°C (0.7kg/cm <sup>2</sup> ) 30min	O	O	O
		121°C (1.0kg/cm <sup>2</sup> ) 20min	X	O	O
		126°C (1.4kg/cm <sup>2</sup> ) 15min	X	X	X
	Boiling sterilization	15-30min	O	O	O
	Ultraviolet sterilization	200-300nm	X	X	X
	Gas sterilization	Ethylene oxide	O	X	O
		Formaldehyde	O	O	O

PA: polyallomer    PC: polycarbonate    PP: polypropylene

### 11.2.2. PC centrifuge tube cleaning

PC material has relatively low chemical stability to alkaline solvent, therefore use of cleaning agent with pH value of over 9 should be avoided. Some neutral cleaning agents still have pH value of over 9 after being diluted as recommended by the vendor, therefore use of cleaning agent with pH value of 7-9



only is recommended.

### 11.2.3. Autoclaving of PA, PC and PP centrifuge tube

PA begins softening at the temperature of 120°C, while PC and PP begin softening at 130°C. Generally, PA may be sterilized for 30 min at 115°C (0.7 kg/cm<sup>2</sup>), while PC and PP may be sterilized for 20 min at 121°C (1.0 kg/cm<sup>2</sup>). Too high temperature would result in deformation of centrifuge tube.

When autoclave is used, take the following steps:

- (1) Place the centrifuge tube upright with opening facing upward. If the centrifuge tube is placed in an inclined or horizontal manner, it will deform due to the effect of gravity.
- (2) Remove the threaded cover and inner cover to prevent deformation or crack of the centrifuge tube.
- (3) Take the centrifuge tube only when the autoclave cools down to the room temperature.

### 11.2.4. Service life of centrifuge tube

The service life of plastic centrifuge tube depends upon the nature of sample, rotor speed and centrifugation temperature. When the plastic centrifuge tube is used for centrifugation of conventional neutral samples (pH5-pH9), its estimated service life at the maximum rotation speed is as follows:

High-quality centrifuge tube (PA, PC, PP): 30-50 times.

Conventional centrifuge tube: about 10 times (frequency of use may be increased in case of low-speed application use)

The service life of centrifuge tube is also related to the cleaning and sterilization conditions.

**Note: Never use any centrifuge tube with cracks.**

## 12. RCF calculation

Relative centrifugal force (RCF) can be calculated using the following formula:

$$RCF=1.118 \times r \times n^2 \times 10^{-5}$$

r-rotation radius, unit: cm; n-rotation speed, unit- rpm

## 13. Ordering information

Order code	Model	Description
9013111121	D1524R	Tabletop high-speed refrigerated micro-centrifuge
<b>Accessories</b>		
19400002	AS24-2	Rotor package, suitable for D1524R, maximum speed 15,000 rpm, maximum capacity 2 ml*24
19400003	AS36-05	Rotor package, suitable for D1524R, maximum speed 15,000 rpm, maximum capacity 0.5 ml*36
19400004	AS4-PCR8	Rotor package, suitable for D1524R, maximum speed 15,000 rpm, maximum capacity 4-PCR8
19400032	AS12-V5	Rotor package, suitable for D1524R, maximum speed 15,000 rpm, maximum capacity 5ml*12
19400012	AS18-5	Rotor package, suitable for D1524R, maximum speed 15,000 rpm, maximum capacity 5 ml*18
19500001	A02P2	0.2 ml rotor adaptor, suitable for A12-2/AS24-2 rotor, 24 pcs/pk
19500002	A05P2	0.5 ml rotor adaptor, suitable for A12-2/AS24-2 rotor, 24 pcs/pk
19500003	A02P05	0.2 ml rotor adaptor, suitable for AS36-05 rotor, 36 pcs/pk

## 14. Warranty

### 14.1. Unit warranty

The entire unit will have two-year warranty period commencing from delivery date under the conditions of normal maintenance.

### 14.2. Rotor warranty

The rotor will have 5-year warranty period from the date of delivery. Don't use any rotor damaged due to corrosion or fatigue. The damage to the entire unit or rotor due to any of the following reasons is outside the scope of warranty:

- (1) Damage due to improper installation;
- (2) Damage due to brutal or improper operation;
- (3) Damage due to relocation or transport after completion of installation;

- (4) Damage due to dismantling or modification by any unauthorized entity or individual;
- (5) Damage due to use any parts not supplied by our company, such as rotor and adaptor;
- (6) Damage due to natural disasters, including fire and earthquake;
- (7) Wearing parts and parts with warranty period.

## 15. After-sales services

To ensure safe and efficient operation of the centrifuge, periodical maintenance is required. If the centrifuge fails, don't attempt to repair it. Please contact the service center.